

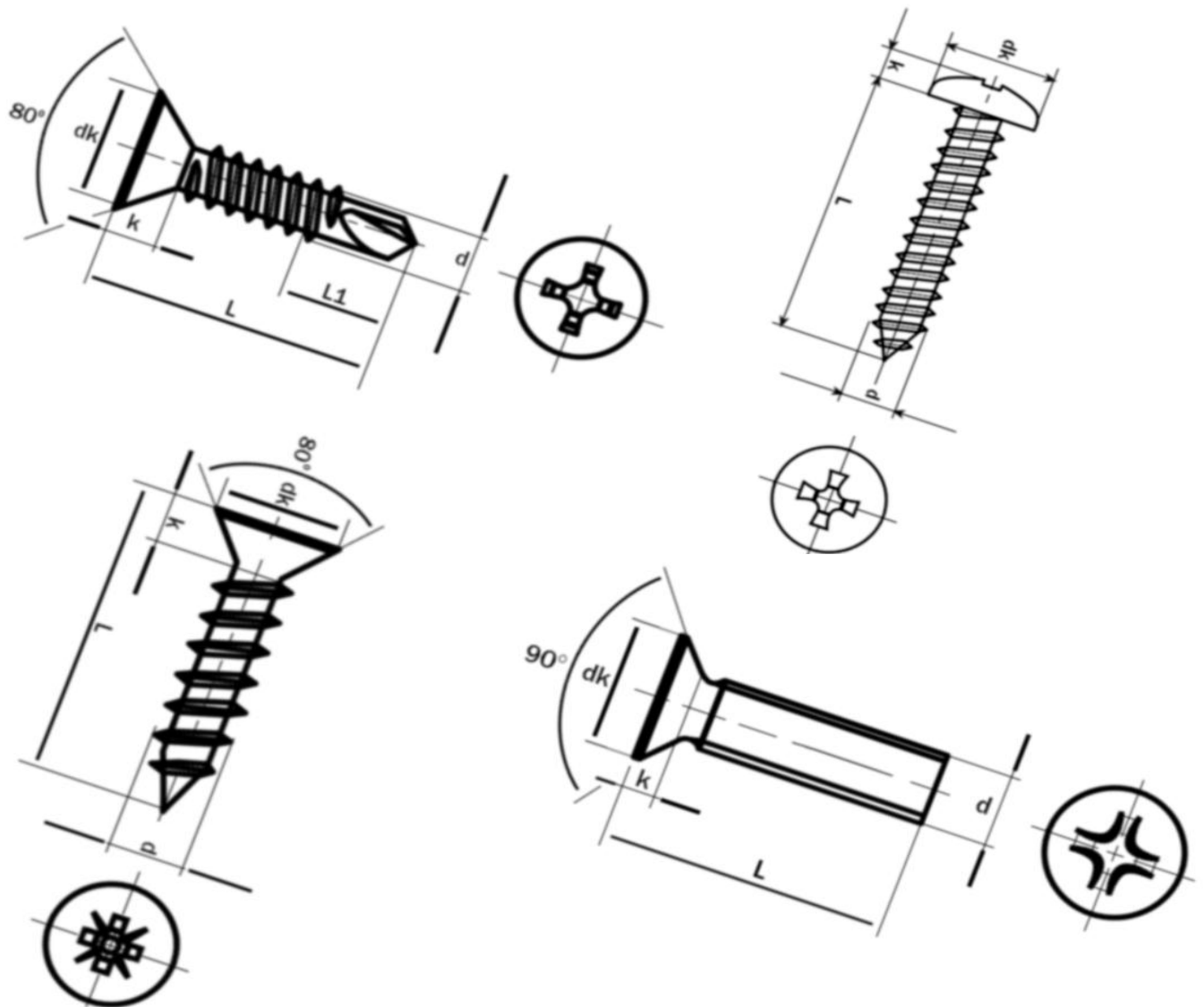

SUMINISTROS INDUSTRIALES



TARIFA TORNILLOS

2010

INDICE

<i>Tornillo cabeza hexagonal</i>	<i>DIN - 933 6.8</i>	<i>Pag. 1</i>
<i>Tornillo cabeza hexagonal</i>	<i>DIN - 933 6.8 ZINCADO</i>	<i>Pag. 2</i>
<i>Tornillo cabeza hexagonal</i>	<i>DIN - 933 8.8</i>	<i>Pag. 3</i>
<i>Tornillo cabeza hexagonal</i>	<i>DIN - 933 8.8 ZINCADO</i>	<i>Pag. 4</i>
<i>Tornillo cabeza hexagonal</i>	<i>DIN - 931 6.8</i>	<i>Pag. 5</i>
<i>Tornillo cabeza hexagonal</i>	<i>DIN - 931 6.8 ZINCADO</i>	<i>Pag. 6</i>
<i>Tornillo cabeza hexagonal</i>	<i>DIN - 931 8.8</i>	<i>Pag. 7</i>
<i>Tornillo cabeza hexagonal</i>	<i>DIN - 931 8.8 ZINCADO</i>	<i>Pag. 8</i>
<i>Tuercas</i>	<i>DIN - 934 Y 985</i>	<i>Pag. 9</i>
<i>Arandelas</i>	<i>DIN - 125, 127 Y 9021</i>	<i>Pag. 10</i>
<i>Varilla roscada</i>	<i>DIN - 975</i>	<i>Pag. 11</i>
<i>Tornillos rosca metal</i>	<i>DIN - 7985</i>	<i>Pag. 12</i>
<i>Tornillos rosca metal</i>	<i>DIN - 965</i>	<i>Pag. 13</i>
<i>Tornillos rosca metal</i>	<i>DIN - 84</i>	<i>Pag. 14</i>
<i>Tornillos rosca metal</i>	<i>DIN - 963</i>	<i>Pag. 15</i>
<i>Tornillo rosca chapa</i>	<i>DIN - 7981</i>	<i>Pag. 16</i>
<i>Tornillo rosca chapa</i>	<i>DIN - 7982</i>	<i>Pag. 17</i>
<i>Tornillo rosca chapa</i>	<i>DIN - 7971</i>	<i>Pag. 18</i>
<i>Tornillo rosca chapa</i>	<i>DIN - 7972</i>	<i>Pag. 19</i>
<i>Tornillo punta broca</i>	<i>DIN - 7504-N</i>	<i>Pag. 20</i>
<i>Tornillo punta broca</i>	<i>DIN - 7504-P</i>	<i>Pag. 21</i>
<i>Tornillo punta broca</i>	<i>DIN - 7504-K</i>	<i>Pag. 22</i>
<i>Tornillo aglomerado Pozidriv</i>	<i>DIN - 7505</i>	<i>Pag. 23</i>
<i>Tornillo aglomera rosca madera</i>	<i>DIN - RA-72</i>	<i>Pag. 24</i>
<i>Tornillo tirafondo</i>	<i>DIN - 571</i>	<i>Pag. 25</i>
<i>Tornillo Tirador</i>		<i>Pag. 26</i>
<i>Tornillo Silla</i>		<i>Pag. 27</i>
<i>Taco Nylon</i>		<i>Pag. 28</i>



SUMINISTROS INDUSTRIALES



C/ LA RIOJA, 17

03006 ALICANTE

TLF. 965114462*

FAX. 965103353

e-mail: info@rodaunion.es

web: www.rodaunion.es



DIN-933 6.8

Tornillo cabeza hexagonal todo rosca Calidad 6.8

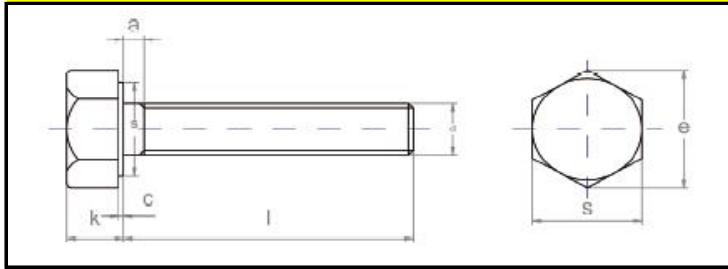

Metrica	M-4	M-5	M-6	M-7	M-8	M-10	M-12	M-14	M-16	M-18	M-20	M-22	M-24
Paso	0,7	0,8	1	1	1,25	1,5	1,75	2	2	2,5	2,5	3	3
K	2,8	3,5	4	5	5,5	7	8	9	10	12	13	14	15
S	7	8	10	11	13	17	19	22	24	27	30	32	36

PRECIOS UNIDAD

METRICAS	M-4	M-5	M-6	M-7	M-8	M-10	M-12	M-14	M-16	M-18	M-20	M-22	M-24
10	0,0391	0,0391	0,0391	0,0787	0,0787								
12	0,0391	0,0391	0,0391	0,0787	0,0787	0,2827							
14		0,0391	0,0391										
16	0,0391	0,0391	0,0391	0,0585	0,0585	0,1494	0,2066						
20	0,0424	0,0424	0,0424	0,0646	0,0646	0,1292	0,1864	0,3473	0,4409				
25	0,0458	0,0458	0,0458	0,0707	0,0707	0,1367	0,2006	0,3473	0,4409				
30	0,0492	0,0492	0,0492	0,0767	0,0767	0,1441	0,2154	0,3473	0,4409	0,7862	0,8637		
35	0,0539	0,0539	0,0539	0,0835	0,0835	0,1548	0,2268	0,3473	0,4624	0,7862	0,8637	1,4001	
40	0,0585	0,0585	0,0585	0,0902	0,0902	0,1662	0,2390	0,3614	0,4847	0,7862	0,8637	1,4001	1,7293
45	0,0694	0,0694	0,0694	0,0983	0,0983	0,1804	0,2524	0,3749	0,5049	0,8010	0,8757	1,4203	1,7293
50	0,0808	0,0808	0,0808	0,1064	0,1064	0,1952	0,2659	0,3898	0,5250	0,8286	0,8899	1,4405	1,7293
55		0,2558	0,1043	0,1185	0,1185	0,2262	0,2908	0,4328	0,5654	0,8852	0,9545	1,5213	1,8464
60		0,2558	0,1144	0,1279	0,1279	0,2262	0,2908	0,4328	0,5654	0,8852	0,9545	1,5213	1,8464
65			0,1616		0,1629	0,2537	0,3366	0,4820	0,6058	0,9841	1,0467	1,6559	2,0147
70		0,3096	0,1616	0,1629	0,1629	0,2537	0,3366	0,4820	0,6058	0,9841	1,0467	1,6559	2,0147
75			0,1649		0,1999	0,2881	0,3837	0,5392	0,6496	1,0871	1,2116	1,8444	2,1810
80			0,1649	0,1999	0,1999	0,2881	0,3837	0,5392	0,6496	1,0871	1,2116	1,8444	2,1810
90			0,2807	0,2807	0,2807	0,3891	0,4409	0,6092	0,7270	1,2150	1,3079	2,0059	2,3789
100			0,3312	0,3312	0,3312	0,4234	0,4893	0,6946	0,8051	1,3416	1,4405	2,2079	2,5848
110					0,4443	0,5351	0,7337	0,9915	1,0467	1,6875	2,0308	3,2310	3,6618
120					0,5487	0,6206	0,7573	1,0938	1,2224	2,0282	2,3526	3,7695	4,2205
130							2,9618	3,7022	3,7022	5,5197	5,5197	7,1352	7,1352
140							3,1301	3,9378	3,9378	5,9909	5,9909		7,6737
150							3,3657	4,1734	4,1734	6,3948	6,3948		8,1449
160							3,7022		4,5100				
170													
180													
190													
200													
220													
240													
260													
280													
300													

OTRAS MEDIDAS - CONSULTAR PRECIO Y PLAZO



DIN-933 6.8 ZINCADO

Tornillo cabeza hexagonal todo rosca Calidad 6.8

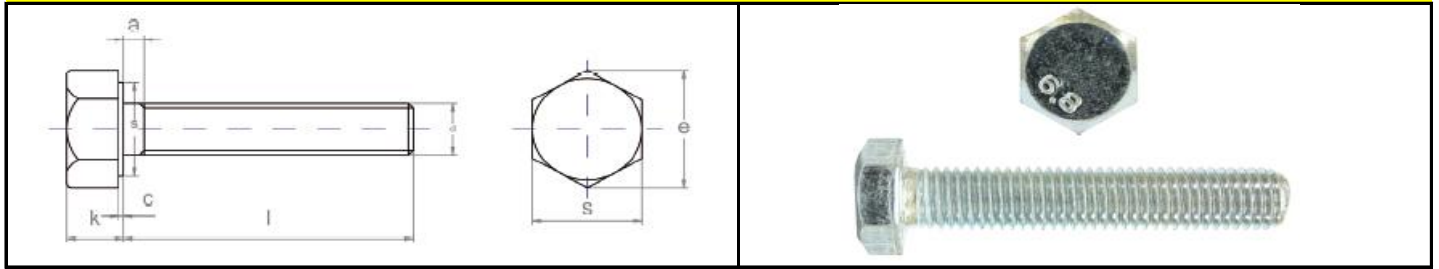

Metrica	M-4	M-5	M-6	M-7	M-8	M-10	M-12	M-14	M-16	M-18	M-20	M-22	M-24
Paso	0,7	0,8	1	1	1,25	1,5	1,75	2	2	2,5	2,5	3	3
K	2,8	3,5	4	5	5,5	7	8	9	10	12	13	14	15
S	7	8	10	11	13	17	19	22	24	27	30	32	36

PRECIOS UNIDAD

METRICA	M-4	M-5	M-6	M-7	M-8	M-10	M-12	M-14	M-16	M-18	M-20	M-22	M-24
10	0,0489	0,0489	0,0489	0,0984	0,0984								
12	0,0489	0,0489	0,0489	0,0984	0,0984	0,3534							
14		0,0489	0,0489										
16	0,0489	0,0489	0,0489	0,0731	0,0731	0,1868	0,2583						
20	0,0530	0,0530	0,0530	0,0808	0,0808	0,1615	0,2330	0,4341	0,5511				
25	0,0573	0,0573	0,0573	0,0884	0,0884	0,1709	0,2508	0,4341	0,5511				
30	0,0615	0,0615	0,0615	0,0959	0,0959	0,1801	0,2693	0,4341	0,5511	0,9828	1,0796		
35	0,0674	0,0674	0,0674	0,1044	0,1044	0,1935	0,2835	0,4341	0,5780	0,9828	1,0796	1,7501	
40	0,0731	0,0731	0,0731	0,1128	0,1128	0,2078	0,2988	0,4518	0,6059	0,9828	1,0796	1,7501	2,1616
45	0,0868	0,0868	0,0868	0,1229	0,1229	0,2255	0,3155	0,4686	0,6311	1,0013	1,0946	1,7754	2,1616
50	0,1010	0,0808	0,0808	0,1330	0,1330	0,2440	0,3324	0,4873	0,6563	1,0358	1,1124	1,8006	2,1616
55		0,3198	0,1304	0,1481	0,1481	0,2828	0,3635	0,5410	0,7068	1,1065	1,1931	1,9016	2,3080
60		0,3198	0,1430	0,1599	0,1599	0,2828	0,3635	0,5410	0,7068	1,1065	1,1931	1,9016	2,3080
65			0,2020		0,2036	0,3171	0,4208	0,6025	0,7573	1,2301	1,3084	2,0699	2,5184
70		0,3870	0,2020	0,2036	0,2036	0,3171	0,4208	0,6025	0,7573	1,2301	1,3084	2,0699	2,5184
75			0,2061		0,2499	0,3601	0,4796	0,6740	0,8120	1,3589	1,5145	2,3055	2,7263
80			0,2061	0,2499	0,2499	0,3601	0,4796	0,6740	0,8120	1,3589	1,5145	2,3055	2,7263
90			0,3509	0,3509	0,3509	0,4864	0,5511	0,7615	0,9088	1,5188	1,6349	2,5074	2,9736
100			0,4140	0,4140	0,4140	0,5293	0,6116	0,8683	1,0064	1,6770	1,8006	2,7599	3,2310
110					0,5554	0,6689	0,9171	1,2394	1,3084	2,1094	2,5385	4,0388	4,5773
120					0,6859	0,7758	0,9466	1,3673	1,5280	2,5353	2,9408	4,7119	5,2756
130							3,7020	4,6278	4,6278	6,8996	6,8996	8,9190	8,9190
140							3,9126	4,9223	4,9223	7,4886	7,4886		9,5921
150							4,2071	5,2168	5,2168	7,9935	7,9935		10,1811
160							4,6278		5,6375				
170													
180													
190													
200													
220													
240													
260													
280													
300													

OTRAS MEDIDAS - CONSULTAR PRECIO Y PLAZO



DIN-933 8.8

Tornillo cabeza hexagonal todo rosca Calidad 8.8

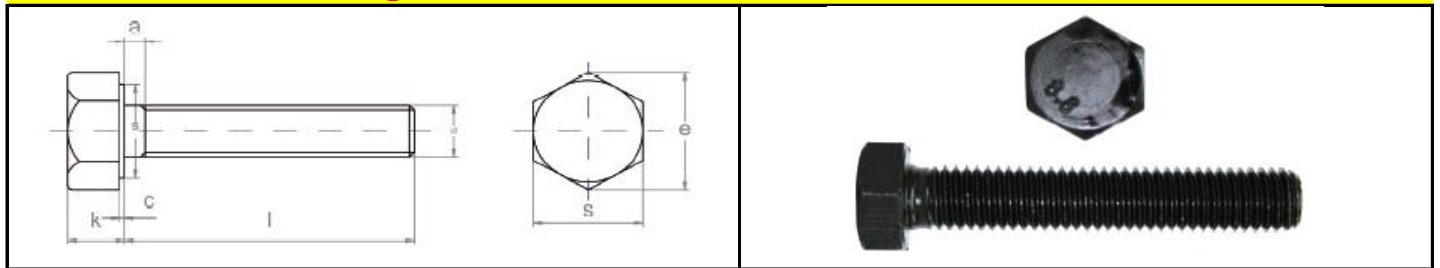

Metrica	M-4	M-5	M-6	M-7	M-8	M-10	M-12	M-14	M-16	M-18	M-20	M-22	M-24
Paso	0,7	0,8	1	1	1,25	1,5	1,75	2	2	2,5	2,5	3	3
K	2,8	3,5	4	5	5,5	7	8	9	10	12	13	14	15
S	7	8	10	11	13	17	19	22	24	27	30	32	36

PRECIOS UNIDAD

METRICAS	M-4	M-5	M-6	M-7	M-8	M-10	M-12	M-14	M-16	M-18	M-20	M-22	M-24
10	0,1265	0,0573	0,0573	0,1349	0,1349								
12	0,1265	0,0573	0,0573	0,1349	0,1349								
14	0,1265	0,0573	0,0573		0,1349								
16	0,1265	0,0410	0,0590	0,1021	0,1021	0,1804	0,3154						
20	0,1518	0,0632	0,0632	0,1029	0,1029	0,1804	0,2833	0,4680	0,7505				
25	0,1602	0,0700	0,0700	0,1121	0,1121	0,1931	0,2960	0,4680	0,6577				
30	0,1686	0,0751	0,0751	0,1282	0,1282	0,2091	0,3179	0,5295	0,6493	1,5094	1,5094		
35	0,2952	0,0810	0,0810	0,1417	0,1417	0,2293	0,3510	0,5321	0,6737	1,5094	1,5094		
40	0,3204	0,0894	0,0894	0,1518	0,1518	0,2437	0,3693	0,5980	0,7332	1,5266	1,4183	2,5128	2,5128
45	0,4469	0,1231	0,1231	0,1695	0,1695	0,2639	0,4141	0,6425	0,7665	1,4621	1,4621	2,3045	2,3045
50	0,4469	0,1290	0,1290	0,1821	0,1917	0,2934	0,4292	0,6948	0,8340	1,5212	1,5212	2,3045	2,3045
55		0,1771	0,1771		0,2040	0,3179	0,4638	0,7648	0,8694	1,6097	1,6097	2,5600	2,5600
60		0,1965	0,1965	0,2243	0,2243	0,3963	0,5127	0,8340	0,9368	1,7573	1,7573	2,8315	2,8315
65			0,2192		0,2597	0,4697	0,6915	1,0119	1,0928	1,9065	1,9065	3,2506	3,2506
70			0,2192		0,2597	0,4697	0,6915	1,0119	1,0928	1,9065	1,9065	3,2506	3,2506
75			0,2724		0,3584	0,5565	0,8011	1,1721	1,1797	2,1181	2,1181	3,5660	3,5660
80			0,2724		0,3584	0,5565	0,8011	1,1721	1,1797	2,1181	2,1181	3,5660	3,5660
90					0,4191	0,5987	0,8854	1,2648	1,5178	2,4242	2,4242	4,4379	4,4379
100					0,5042	0,6830	0,9275	1,4335	1,6527	2,7228	2,7228	4,6377	4,6377
110						0,6830	1,2067	1,7202	4,3173	6,6783	6,6783	8,7695	8,7695
120						1,4900	1,5689	4,6377	4,6377	7,1674	7,1674	9,3597	9,3597
130							1,8240	5,1015	5,1015	7,6059	7,6059	9,8657	9,8657
140							2,0870	5,4303	5,4303	7,8419	7,8419	10,5402	10,5402
150							2,8365	5,7086	5,7086	8,4322	8,4322	11,2148	11,2148
160									6,2398	9,0225	9,0225	12,5640	12,5640
170									8,0106	10,6246	10,6246	14,0818	14,0818
180									8,0106	10,6246	10,6246	14,0818	14,0818
190									8,7695	11,7208	11,7208	15,4309	15,4309
200									8,7695	11,7208	11,7208	15,4309	15,4309
220													
240													
260													
280													
300													

OTRAS MEDIDAS - CONSULTAR PRECIO Y PLAZO



DIN-933 8.8 ZINCADO

Tornillo cabeza hexagonal todo rosca Calidad 8.8

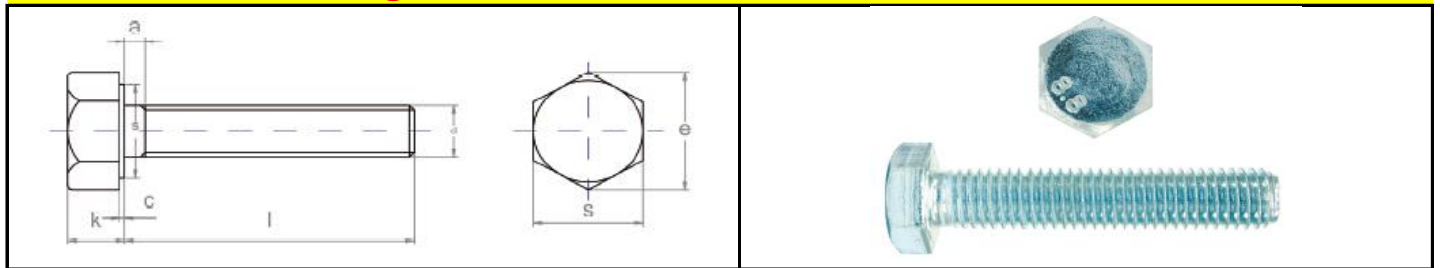

Metrica	M-4	M-5	M-6	M-7	M-8	M-10	M-12	M-14	M-16	M-18	M-20	M-22	M-24
Paso	0,7	0,8	1	1	1,25	1,5	1,75	2	2	2,5	2,5	3	3
K	2,8	3,5	4	5	5,5	7	8	9	10	12	13	14	15
S	7	8	10	11	13	17	19	22	24	27	30	32	36

PRECIOS UNIDAD

METRICAS	M-4	M-5	M-6	M-7	M-8	M-10	M-12	M-14	M-16	M-18	M-20	M-22	M-24
10	0,1581	0,0716	0,0716	0,1686	0,1686								
12	0,1581	0,0716	0,0716	0,1686	0,1686								
14	0,1581	0,0716	0,0716		0,1686								
16	0,1581	0,0513	0,0738	0,1276	0,1276	0,2255	0,3943						
20	0,1898	0,0790	0,0790	0,1286	0,1286	0,2255	0,3541	0,5850	0,9381				
25	0,2003	0,0875	0,0875	0,1401	0,1401	0,2414	0,3700	0,5850	0,8221				
30	0,2108	0,0939	0,0939	0,1603	0,1603	0,2614	0,3974	0,6619	0,8116	1,8868	1,8868		
35	0,3690	0,1013	0,1013	0,1771	0,1771	0,2866	0,4388	0,6651	0,8421	1,8868	1,8868		
40	0,4005	0,1118	0,1118	0,1898	0,1898	0,3046	0,4616	0,7475	0,9165	1,9083	1,7729	3,1410	3,1410
45	0,5586	0,1539	0,1539	0,2119	0,2119	0,3299	0,5176	0,8031	0,9581	1,8276	1,8276	2,8806	2,8806
50	0,5586	0,1613	0,1613	0,2276	0,2396	0,3668	0,5365	0,8685	1,0425	1,9015	1,9015	2,8806	2,8806
55		0,2214	0,2214		0,2550	0,3974	0,5798	0,9560	1,0868	2,0121	2,0121	3,2000	3,2000
60		0,2456	0,2456	0,2804	0,2804	0,4954	0,6409	1,0425	1,1710	2,1966	2,1966	3,5394	3,5394
65			0,2740		0,3246	0,5871	0,8644	1,2649	1,3660	2,3831	2,3831	4,0633	4,0633
70			0,2740		0,3246	0,5871	0,8644	1,2649	1,3660	2,3831	2,3831	4,0633	4,0633
75			0,3405		0,4480	0,6956	1,0014	1,4651	1,4746	2,6476	2,6476	4,4575	4,4575
80			0,3405		0,4480	0,6956	1,0014	1,4651	1,4746	2,6476	2,6476	4,4575	4,4575
90					0,5239	0,7484	1,1068	1,5810	1,8973	3,0303	3,0303	5,5474	5,5474
100					0,6303	0,8538	1,1594	1,7919	2,0659	3,4035	3,4035	5,7971	5,7971
110						0,8538	1,5084	2,1503	5,3966	8,3479	8,3479	10,9619	10,9619
120						1,8625	1,9611	5,7971	5,7971	8,9593	8,9593	11,6996	11,6996
130							2,2800	6,3769	6,3769	9,5074	9,5074	12,3321	12,3321
140							2,6088	6,7879	6,7879	9,8024	9,8024	13,1753	13,1753
150							3,5456	7,1358	7,1358	10,5403	10,5403	14,0185	14,0185
160									7,7998	11,2781	11,2781	15,7050	15,7050
170									10,0133	13,2808	13,2808	17,6023	17,6023
180									10,0133	13,2808	13,2808	17,6023	17,6023
190									10,9619	14,6510	14,6510	19,2886	19,2886
200									10,9619	14,6510	14,6510	19,2886	19,2886
220													
240													
260													
280													
300													

OTRAS MEDIDAS - CONSULTAR PRECIO Y PLAZO



DIN-931 6.8

Tornillo cabeza hexagonal media rosca Calidad 6.8

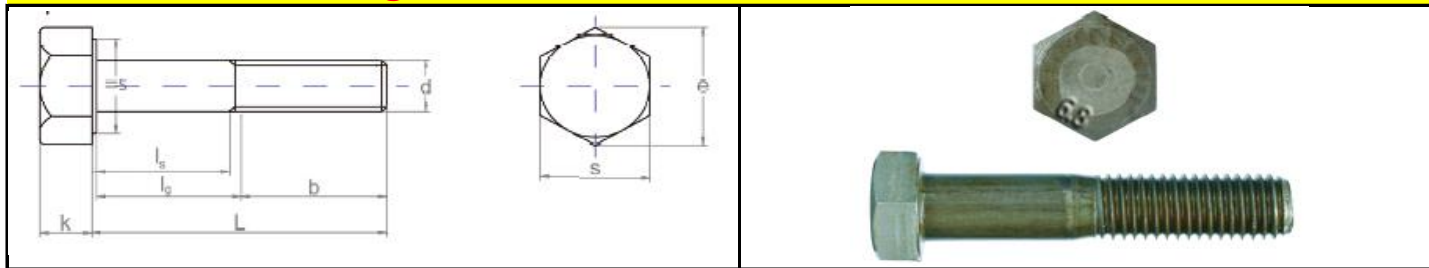

Metrica	M-4	M-5	M-6	M-7	M-8	M-10	M-12	M-14	M-16	M-18	M-20	M-22	M-24
Paso	0,7	0,8	1	1	1,25	1,5	1,75	2	2	2,5	2,5	3	3
b1) L ≤ 125		18	18		22	26	30	34	38	42	46	50	54
b2) L 125 ≤ 200		22	24		28	32	36	40	44	48	52	56	60
b3) L > 200						45	49	53	57	61	65	69	73
K	2,8	3,5	4		5,5	7	8	9	10	12	13	14	15
S	7	8	10		13	17	19	22	24	27	30	32	36

PRECIOS UNIDAD

METRICA	M-4	M-5	M-6	M-7	M-8	M-10	M-12	M-14	M-16	M-18	M-20	M-22	M-24
25													
30	0,0685	0,0572	0,0572										
35		0,0619	0,0619		0,0896								
40	0,0660	0,0660	0,0660		0,0969	0,1784							
45		0,0700	0,0700		0,1050	0,1945	0,2800						
50	0,0747	0,0747	0,0747		0,1124	0,2107	0,2935	0,4173					
55		0,0821	0,0821		0,1218	0,2302	0,3069	0,4359	0,5587				
60		0,0896	0,0896		0,1313	0,2491	0,3204	0,4544	0,5823	0,9289			
65			0,1131		0,1636	0,2726	0,3420	0,4914	0,6327	1,0030	1,0750		
70		0,1131	0,1131		0,1636	0,2726	0,3420	0,4914	0,6327	1,0030	1,0750	1,8848	
75					0,2053	0,2982	0,3723	0,5392	0,6799	1,0575	1,1571	2,5243	2,3162
80		0,1501	0,1501		0,2053	0,2982	0,3723	0,5392	0,6799	1,0575	1,1571	2,0194	2,3162
90			0,1804		0,2329	0,3238	0,4045	0,6092	0,7303	1,1282	1,2352	2,0531	2,4408
100			0,2093		0,2733	0,3709	0,4443	0,6665	0,7775	1,1995	1,3315	2,1675	2,5783
110					0,3534	0,4200	0,5055	0,7411	0,8475	1,2884	1,4243	2,3021	2,7969
120					0,4066	0,4941	0,5627	0,8145	0,9296	1,4284	1,5448	2,4839	3,0473
130					0,4618	0,6624	0,6893	1,0682	1,1093	1,5711	1,6795	2,7598	3,2997
140					0,5385	0,7593	0,8313	1,2116	1,2184	1,7138	1,8801	3,1166	3,6228
150					0,6731	0,8233	0,8872	1,3139	1,3184	1,9433	2,0827	3,4666	3,9803
160					1,6424	1,6424	1,6424	1,6424	1,9521	2,4233	2,8272	4,8331	5,0088
170					1,7232	1,7232	1,7232	2,0194	2,2887	2,8272	3,4330	5,6812	5,8233
180					1,7771	1,7771	1,7771	2,2213	2,4233	3,4330	3,6349	5,8563	6,0885
190						1,9521	2,2887	2,6252	3,2984	3,9042	4,1734	6,3275	6,3275
200						1,9521	2,2887	2,6252	3,2984	3,9042	4,1734	6,6640	6,6640
220											7,4045		
240													
260													
280													
300													

OTRAS MEDIDAS - CONSULTAR PRECIO Y PLAZO



DIN-931 6.8 ZINCADO

Tornillo cabeza hexagonal media rosca Calidad 6.8

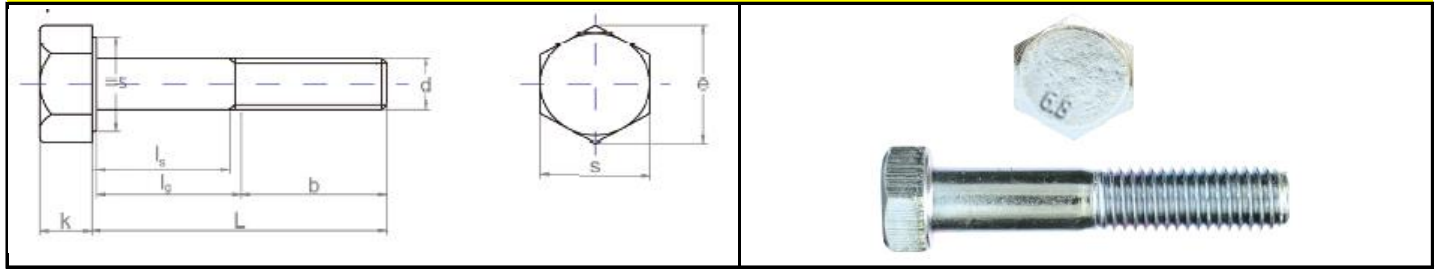

Metrica	M-4	M-5	M-6	M-7	M-8	M-10	M-12	M-14	M-16	M-18	M-20	M-22	M-24
Paso	0,7	0,8	1	1	1,25	1,5	1,75	2	2	2,5	2,5	3	3
b1) L ≤ 125		18	18		22	26	30	34	38	42	46	50	54
b2) L 125 ≤ 200		22	24		28	32	36	40	44	48	52	56	60
b3) L > 200						45	49	53	57	61	65	69	73
K	2,8	3,5	4		5,5	7	8	9	10	12	13	14	15
S	7	8	10		13	17	19	22	24	27	30	32	36

PRECIOS UNIDAD

METRICA	M-4	M-5	M-6	M-7	M-8	M-10	M-12	M-14	M-16	M-18	M-20	M-22	M-24
25													
30	0,0856	0,0715	0,0715										
35		0,0774	0,0774		0,1120								
40	0,0825	0,0825	0,0825		0,1211	0,2230							
45		0,0875	0,0875		0,1313	0,2431	0,3500						
50	0,0934	0,0934	0,0934		0,1405	0,2634	0,3669	0,5216					
55		0,1026	0,1026		0,1523	0,2878	0,3836	0,5449	0,6984				
60		0,1120	0,1120		0,1641	0,3114	0,4065	0,5680	0,7279	1,1611			
65			0,1414		0,2045	0,3408	0,4275	0,6143	0,7909	1,2538	1,3438		
70		0,1414	0,1414		0,2045	0,3408	0,4275	0,6143	0,7909	1,2538	1,3438	2,3560	
75					0,2566	0,3728	0,4654	0,6740	0,8499	1,3219	1,4464	3,1554	2,8953
80		0,1876	0,1876		0,2566	0,3728	0,4654	0,6740	0,8499	1,3219	1,4464	2,5243	2,8953
90			0,2255		0,2911	0,4048	0,5056	0,7615	0,9129	1,4103	1,5440	2,5664	3,0510
100			0,2616		0,3416	0,4636	0,5554	0,8331	0,9719	1,4994	1,6644	2,7094	3,2229
110					0,4418	0,5250	0,6319	0,9264	1,0594	1,6105	1,7804	2,8776	3,4961
120					0,5083	0,6176	0,7034	1,0181	1,1620	1,7855	1,9310	3,1049	3,8091
130					0,5773	0,8280	0,8616	1,3353	1,3866	1,9639	2,0994	3,4498	4,1246
140					0,6731	0,9491	1,0391	1,5145	1,5230	2,1423	2,3501	3,8958	4,5285
150					0,8414	1,0291	1,1090	1,6424	1,6480	2,4291	2,6034	4,3333	4,9754
160					2,0530	2,0530	2,0530	2,0530	2,4401	3,0291	3,5340	6,0414	6,2610
170					2,1540	2,1540	2,1540	2,5243	2,8609	3,5340	4,2913	7,1015	7,2791
180					2,2214	2,2214	2,2214	2,7766	3,0291	4,2913	4,5436	7,3204	7,6106
190					2,4401	2,8609	3,2815	4,1230	4,8803	5,2168	7,9094	7,9094	
200					2,4401	2,8609	3,2815	4,1230	4,8803	5,2168	8,3300	8,3300	
220											9,2556		
240													
260													
280													
300													

OTRAS MEDIDAS - CONSULTAR PRECIO Y PLAZO



DIN-931 8.8

Tornillo cabeza hexagonal media rosca Calidad 8.8

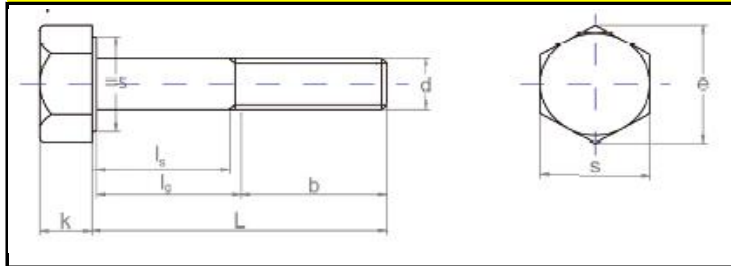

Metrica	M-4	M-5	M-6	M-7	M-8	M-10	M-12	M-14	M-16	M-18	M-20	M-22	M-24
Paso	0,7	0,8	1	1	1,25	1,5	1,75	2	2	2,5	2,5	3	3
b1) L ≤ 125		18	18		22	26	30	34	38	42	46	50	54
b2) L 125 ≤ 200		22	24		28	32	36	40	44	48	52	56	60
b3) L > 200						45	49	53	57	61	65	69	73
K	2,8	3,5	4		5,5	7	8	9	10	12	13	14	15
S	7	8	10		13	17	19	22	24	27	30	32	36

PRECIOS UNIDAD

METRICA	M-4	M-5	M-6	M-7	M-8	M-10	M-12	M-14	M-16	M-18	M-20	M-22	M-24
25		0,0801	0,0751										
30		0,0801	0,0751	0,1552	0,1552	0,2458							
35		0,0860	0,0818	0,1552	0,1552	0,2521							
40		0,0944	0,0894	0,1628	0,1628	0,2521	0,4115						
45		0,1197	0,1164	0,1729	0,1729	0,2791	0,4115	0,7007					
50		0,1425	0,1425	0,1881	0,1881	0,3086	0,4466	0,7332	0,9081				
55		0,1729	0,1585	0,2032	0,2032	0,3348	0,4967	0,7522	0,9081	1,5020			
60		0,1787	0,1787	0,2226	0,2226	0,3550	0,5127	0,8053	0,9616	1,7724	1,9048		
65			0,2462		0,2783	0,4107	0,5666	0,8558	1,0650	1,9048	1,9048	3,1444	
70		0,2462	0,2462	0,2783	0,2783	0,4107	0,5666	0,8558	1,0650	1,9048	1,9048	3,1444	3,4058
75			0,3465		0,3272	0,4579	0,6434	0,9874	1,1687	2,1173	2,1173	3,4058	3,4058
80			0,3465	0,3272	0,3272	0,4579	0,6434	0,9874	1,1900	2,1173	2,1173	3,4058	3,4058
90			0,4351		0,3896	0,5127	0,7201	1,1426	1,2969	2,2750	2,2750	3,9319	3,9319
100			0,5220		0,4832	0,5666	0,7960	1,3483	1,4537	2,4858	2,4858	4,1908	4,1908
110			1,1805		0,6923	0,7842	0,9360	1,4537	1,6603	2,6443	2,6443	4,7660	4,4269
120			1,5178		0,8061	0,8685	1,0279	1,6620	1,8694	2,9108	2,9108	4,8485	4,8485
130					0,9613	0,9613	1,3188	1,8694	2,0769	3,1739	3,2515	5,2423	5,2423
140					1,2227	1,3407	1,5760	2,0516	2,2573	3,5710	3,5710	6,0273	6,0273
150					1,4588	1,5768	1,6287	2,2573	2,4597	3,9673	3,9673	6,5527	6,8215
160					2,1080	2,1080	2,0855	2,8248	3,0626	4,3645	4,3645	6,8419	6,8419
170					2,3694	2,2683	2,4622	3,0187	3,3729	5,5552	5,5552	7,4557	7,4557
180					2,3694	2,3694	2,4622	3,0187	4,0306	6,0712	6,0712	8,0688	8,0688
190						2,5297	3,0356	6,1555	4,2161	6,5771	6,5771	11,3835	11,3835
200						2,5297	3,0356	6,1555	4,2161	6,5771	6,5771	11,3835	11,3835
220						5,0593	5,2280	6,9987	7,5890	7,5890	7,5890	14,4191	14,4191
240							5,8182	7,4203	7,5890	12,6483	13,6602	16,0212	16,0170
260							6,4928	8,4322	8,4322	13,6602	14,9250	16,9487	18,1292
280							6,9987	8,7695	8,7695	15,1780	16,4428	18,7195	19,8154
300							7,4203	9,4441	9,4441	16,1898	17,7919	20,6589	21,5864

OTRAS MEDIDAS - CONSULTAR PRECIO Y PLAZO



DIN-931 8.8 ZINCADO

Tornillo cabeza hexagonal media rosca Calidad 8.8

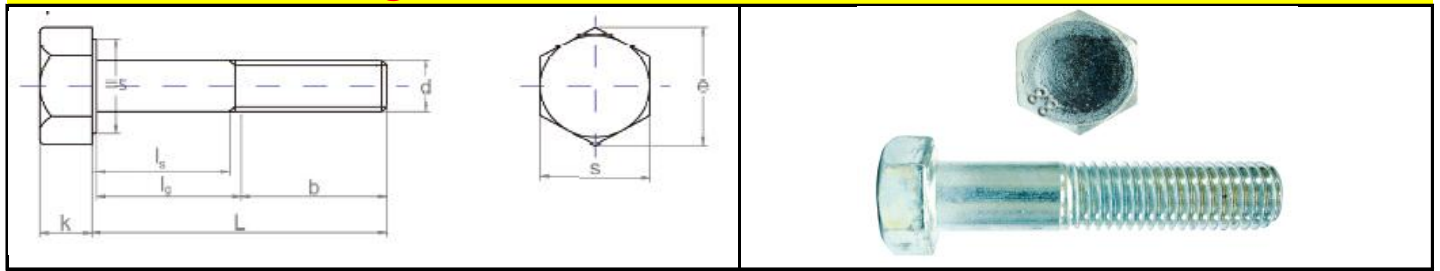

Metrica	M-4	M-5	M-6	M-7	M-8	M-10	M-12	M-14	M-16	M-18	M-20	M-22	M-24
Paso	0,7	0,8	1	1	1,25	1,5	1,75	2	2	2,5	2,5	3	3
b1) L ≤ 125		18	18		22	26	30	34	38	42	46	50	54
b2) L 125 ≤ 200		22	24		28	32	36	40	44	48	52	56	60
b3) L > 200						45	49	53	57	61	65	69	73
K	2,8	3,5	4		5,5	7	8	9	10	12	13	14	15
S	7	8	10		13	17	19	22	24	27	30	32	36

PRECIOS UNIDAD

METRICA	M-4	M-5	M-6	M-7	M-8	M-10	M-12	M-14	M-16	M-18	M-20	M-22	M-24
25		0,1001	0,0939										
30		0,1001	0,0939	0,1940	0,1940	0,3073							
35		0,1075	0,1023	0,1940	0,1940	0,3151							
40		0,1180	0,1118	0,2035	0,2035	0,3151	0,5144						
45		0,1496	0,1455	0,2161	0,2161	0,3489	0,5144	0,8759					
50		0,1781	0,1781	0,2351	0,2351	0,3858	0,5583	0,9165	1,1351				
55		0,2161	0,1981	0,2540	0,2540	0,4185	0,6209	0,9403	1,1351	1,8775			
60		0,2234	0,2234	0,2783	0,2783	0,4438	0,6409	1,0066	1,2020	2,2155	2,3810		
65			0,3078		0,3479	0,5134	0,7083	1,0698	1,3313	2,3810	2,3810	3,9305	
70		0,3078	0,3078	0,3479	0,3479	0,5134	0,7083	1,0698	1,3313	2,3810	2,3810	3,9305	4,2573
75			0,4331		0,4090	0,5724	0,8043	1,2343	1,4609	2,6466	2,6466	4,2573	4,2573
80			0,4331	0,4090	0,4090	0,5724	0,8043	1,2343	1,4875	2,6466	2,6466	4,2573	4,2573
90			0,5439		0,4870	0,6409	0,9001	1,4283	1,6211	2,8438	2,8438	4,9149	4,9149
100			0,6525		0,6040	0,7083	0,9950	1,6854	1,8171	3,1073	3,1073	5,2385	5,2385
110			1,4756		0,8654	0,9803	1,1700	1,8171	2,0754	3,3054	3,3054	5,9575	5,5336
120			1,8973		1,0076	1,0856	1,2849	2,0775	2,3368	3,6385	3,6385	6,0606	6,0606
130					1,2016	1,2016	1,6485	2,3368	2,5961	3,9674	4,0644	6,5529	6,5529
140					1,5284	1,6759	1,9700	2,5645	2,8216	4,4638	4,4638	7,5341	7,5341
150					1,8235	1,9710	2,0359	2,8216	3,0746	4,9591	4,9591	8,1909	8,5269
160					2,6350	2,6350	2,6069	3,5310	3,8283	5,4556	5,4556	8,5524	8,5524
170					2,9618	2,8354	3,0778	3,7734	4,2161	6,9440	6,9440	9,3196	9,3196
180					2,9618	2,9618	3,0778	3,7734	5,0383	7,5890	7,5890	10,0860	10,0860
190						3,1621	3,7945	7,6944	5,2701	8,2214	8,2214	14,2294	14,2294
200						3,1621	3,7945	7,6944	5,2701	8,2214	8,2214	14,2294	14,2294
220						6,3241	6,5350	8,7484	9,4863	9,4863	9,4863	18,0239	18,0239
240							7,2728	9,2754	9,4863	15,8104	17,0753	20,0265	20,0213
260							8,1160	10,5403	10,5403	17,0753	18,6563	21,1859	22,6615
280							8,7484	10,9619	10,9619	18,9725	20,5535	23,3994	24,7693
300							9,2754	11,8051	11,8051	20,2373	22,2399	25,8236	26,9830

OTRAS MEDIDAS - CONSULTAR PRECIO Y PLAZO



DIN-934 / DIN-985

Tuerca hexagonal

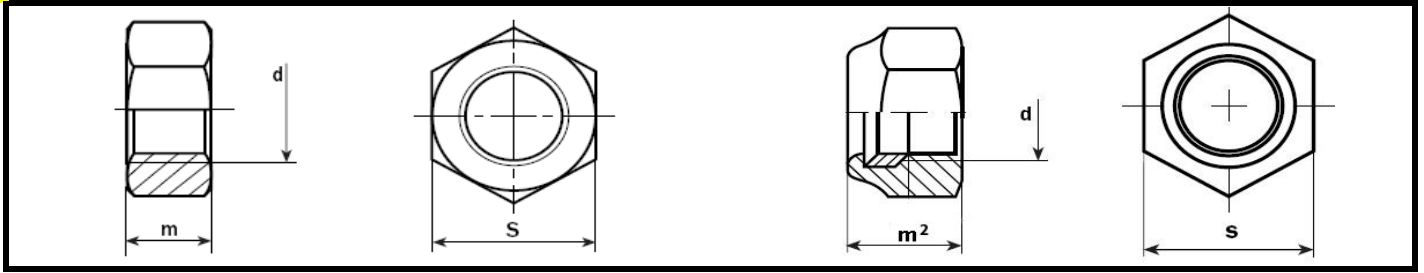

PRECIOS UNIDAD

Precios netos



Metrica d	Paso	s	m	m²	Din-934 6.8	Din-934 6.8	Din-934 8.8	Din-934 8.8	Din-985
					Sin baño	Zincada	Pavonada	Zincada	Zincada
M-3	0,5	5,5	2,4	4	0,0061	0,0077			0,0062
M-4	0,7	7	3,2	5	0,0058	0,0072	0,0138	0,0173	0,0066
M-5	0,8	8	4	5	0,0070	0,0088	0,0155	0,0194	0,0048
M-6	1	10	5	6	0,0119	0,0149	0,0180	0,0225	0,0074
M-7	1	11	5,5	7,5	0,0238	0,0298	0,0325	0,0406	0,0140
M-8	1,25	13	6,5	8	0,0243	0,0304	0,0316	0,0394	0,0152
M-10	1,5	17	8	10	0,0467	0,0584	0,0977	0,1221	0,0302
M-12	1,75	19	10	12	0,0748	0,0935	0,1125	0,1406	0,0463
M-14	2	22	11	14	0,1161	0,1451	0,1414	0,1767	0,0796
M-16	2	24	13	16	0,1439	0,1799	0,2400	0,3000	0,1040
M-18	2,5	27	15	18,5	0,2146	0,2682	0,3209	0,4012	0,1418
M-20	2,5	30	16	20	0,2587	0,3234	0,3768	0,4711	0,1813
M-22	2,5	32	18	22	0,3922	0,4902	0,5402	0,6752	0,2760
M-24	3	36	19	24	0,5490	0,6863	0,6707	0,8384	0,4320
M-27	3	41	22	27	0,9864	1,2330	1,2394	1,5493	0,8260
M-30	3,5	46	24	30	1,3306	1,6633	1,6588	2,0735	1,3400
M-33	3,5	50	26	33	1,9292	2,4101	2,7002	3,3753	
M-36	4	55	29	36					
M-39	4	60	31	39					
M-42	4,5	65	34	42					
M-45	4,5	70	36	45					
M-48	5	75	38	48					
M-52	5	80	42						

Consultar

OTRAS MEDIDAS - CONSULTAR PRECIO Y PLAZO



DIN-125 / DIN-9021 / DIN-127

Arandelas planas, anchas y grower

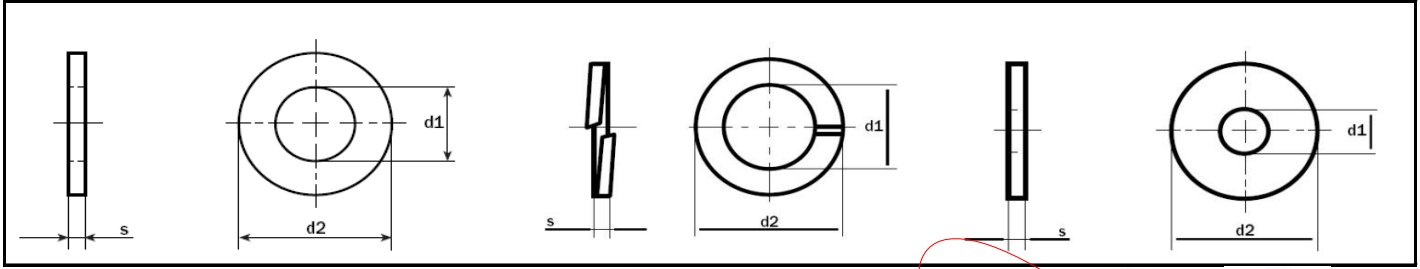

Metrica	d1	d2	s	Din-125		d1	d2	s	Din-127	
				Pulida	Zincada				Pulida	Zincada
M-3	3,2	7	0,5	0,0025	0,0031	3,1	6,7	0,8	0,0051	0,0064
M-4	4,3	9	0,8	0,0040	0,0050	4,1	7,6	0,9	0,0052	0,0065
M-5	5,3	10	1	0,0051	0,0064	5,1	9,2	1,2	0,0059	0,0077
M-6	6,4	12	1,6	0,0103	0,0129	6,1	11,8	1,6	0,0083	0,0111
M-7	7,4	14	1,6	0,0111	0,0138	7,1	12,8	1,6	0,0096	0,0120
M-8	8,4	16	1,6	0,0154	0,0193	8,1	14,8	2	0,0123	0,0171
M-10	10,5	20	2	0,0301	0,0376	10,2	18,1	2,2	0,0180	0,0260
M-12	13	24	2,5	0,0474	0,0593	12,2	21,1	2,5	0,0255	0,0366
M-14	15	28	2,5	0,0720	0,0900	14,2	24,1	3	0,0403	0,0571
M-16	17	30	3	0,0934	0,1167	16,2	27,4	3,5	0,0564	0,0811
M-18	19	34	3	0,0974	0,1218	18,2	29,4	3,5	0,0610	0,0762
M-20	21	37	3	0,1357	0,1696	20,2	33,6	4	0,1083	0,1353
M-22	23	39	3	0,1284	0,1605	22,5	35,9	4	0,1119	0,1591
M-24	25	44	4	0,2560	0,3406	24,5	40	5	0,1818	0,2577
M-27	28	50	4	0,3589	0,4486	27,5	43	5	0,2073	0,2592
M-30	31	56	4	0,3687	0,4608	30,5	48,2	6	0,5100	0,6375
M-33	34	60	5	0,5026	0,6283	33,5	55,2	6		
M-36	37	66	5	0,8808	1,1011	36,5	58,2	6		
M-39	40	72	6	0,9329	1,1661	39,5	61,2	6		
M-42	43	78	7	1,7611	2,2014	42,5	68,2	7		
M-45	46	85	7	1,5929	1,9912	45,5	71,2	7		

Consultar



Metrica	d1	d2	s	Din-9021	
				Pulida	Zincada
M-3				0,0062	0,0078
M-4	4,3	12	1	0,0109	0,0136
M-5	5,3	15	1,6	0,0186	0,0230
M-6	6,4	18	1,6	0,0240	0,0300
M-7	7,4	22	2	0,0330	0,0412
M-8	8,4	25	2	0,0474	0,0592
M-10	10,5	30	2,5	0,0840	0,1050
M-12	13	40	3	0,1866	0,2333
M-14	15	45	3	0,2087	0,2766
M-16	17	50	3	0,2521	0,3343
M-18	19	56	4	0,3786	0,5080
M-20	21	60	4	0,5146	0,6433

PRECIOS UNIDAD

OTRAS MEDIDAS - CONSULTAR PRECIO Y PLAZO



DIN-975

Varilla roscada

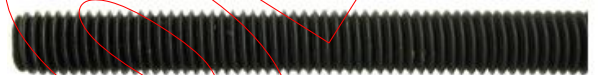
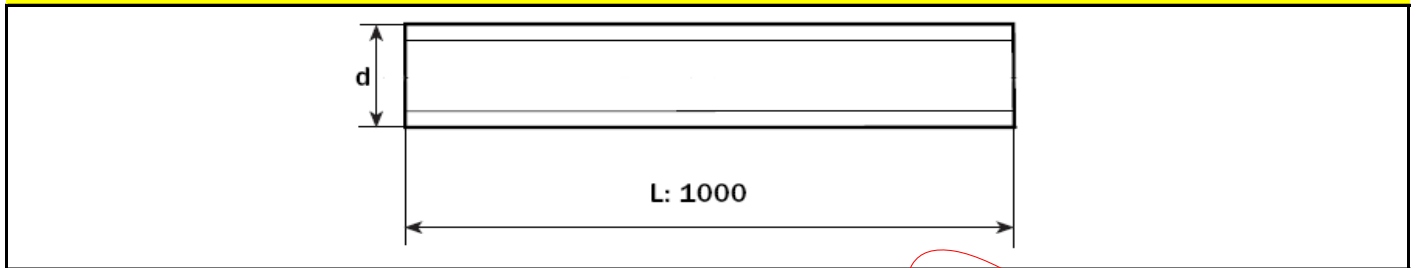

PRECIOS UNIDAD

Metrica d	Paso	Din-975 Hierro	Din-975 Hierro Zincada	Din-975 Acero 8.8
M-3	0,5	0,5890	0,8114	
M-4	0,7	0,6300	0,8114	
M-5	0,8	0,7040	0,8114	4,5000
M-6	1	0,8270	0,8895	3,8250
M-7	1	1,4184	2,0400	
M-8	1,25	1,4000	1,5266	6,3000
M-10	1,5	2,2370	3,2695	8,7735
M-12	1,75	3,2270	3,3897	13,4500
M-14	2	4,4360	4,6699	16,1500
M-16	2	5,9920	6,1904	20,6500
M-18	2,5	7,5100	7,6320	22,9500
M-20	2,5	9,2460	11,5630	28,7500
M-22	2,5	11,6210	11,8399	37,7000
M-24	3	14,4350	17,0500	49,9000
M-27	3	18,8390	21,2758	53,7750
M-30	3,5	23,2420	25,8435	75,8500
M-33	3,5	32,9390	49,2700	94,5500
M-36	4	42,9700	53,7100	98,7500
M-39	4	54,7130	68,3900	
M-42	4,5	65,5100	81,8875	

OTRAS MEDIDAS - CONSULTAR PRECIO Y PLAZO





DIN-7985

Tornillo rosca metal cabeza alomada philips

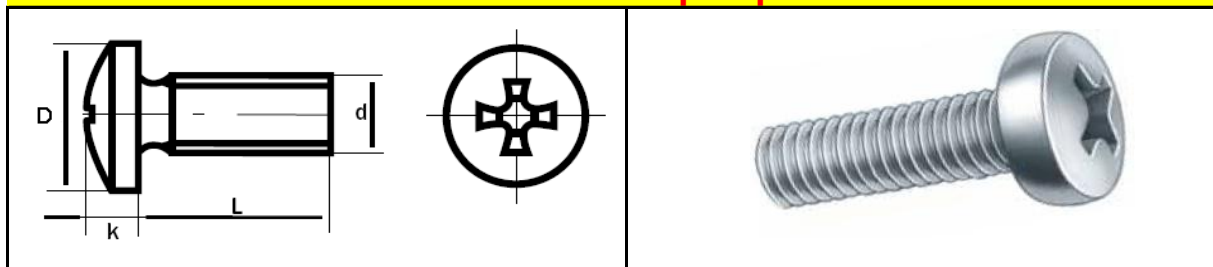

PRECIOS UNIDAD

ROSCA d M	M3	M4	M5	M6	M8
D	6	8	10	12	16
K	2,4	3,1	3,8	4,6	6

LONGITUDES (L)	M3		M4		M5		M6		M8	
	D	K	D	K	D	K	D	K	D	K
6	0,0083	0,0115								
8	0,0083	0,0090								
10	0,0083	0,0092			0,0133		0,0203			
12	0,0086	0,0094			0,0138		0,0217			
16	0,0085	0,0093			0,0144		0,0219			
20	0,0101	0,0104			0,0163		0,0252			
25	0,0118	0,0118			0,0185		0,0282			
30	0,0148	0,0141			0,0207		0,0304			
35	0,0188	0,0166			0,0234		0,0335			
40	0,0208	0,0198			0,0264		0,0370			
45					0,0322		0,0419			
50					0,0357		0,0454			
60										
70										
80										

Bajo Consulta

OTRAS MEDIDAS - CONSULTAR PRECIO Y PLAZO



DIN-965

Tornillo rosca metal cabeza avellanada philips

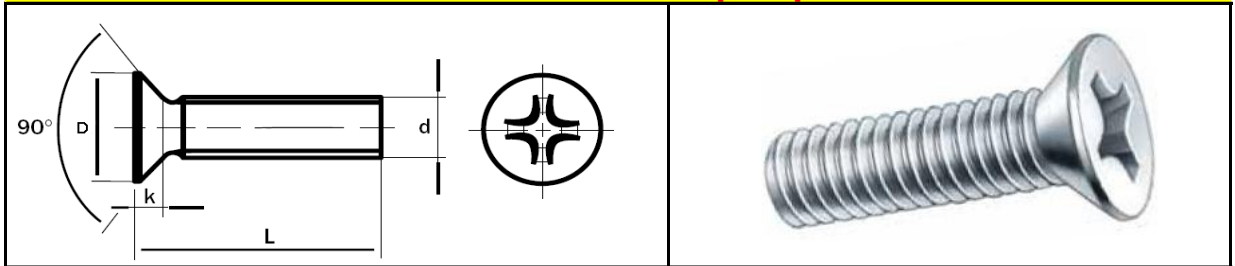

PRECIOS UNIDAD

ROSCA d M	M3	M4	M5	M6	M8
D	5,6	7,5	9,2	11	14,5
K	1,6	2,2	2,5	3	4

LONGITUDES (L)	M3		M4		M5		M6		M8	
	6	8	10	12	16	20	25	30	35	40
6	0,0083	0,0090								
8	0,0083	0,0090								
10	0,0083	0,0092	0,0133	0,0203						
12	0,0086	0,0094	0,0138	0,0217						
16	0,0085	0,0093	0,0144	0,0219						
20	0,0101	0,0104	0,0163	0,0252						
25	0,0118	0,0118	0,0185	0,0282						
30	0,0148	0,0141	0,0207	0,0304						
35	0,0188	0,0166	0,0234	0,0335						
40	0,0208	0,0198	0,0264	0,0370						
45			0,0322	0,0419						
50			0,0357	0,0454						
60										
70										
80										

Bajo Consulta

OTRAS MEDIDAS - CONSULTAR PRECIO Y PLAZO



Tornillo rosca metal cabeza cilindrica

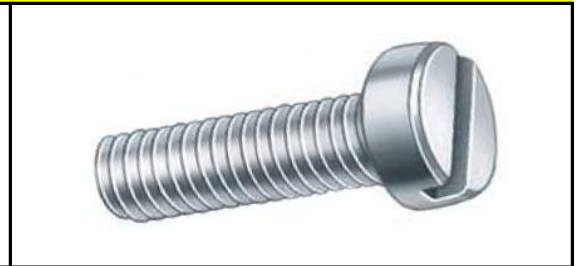
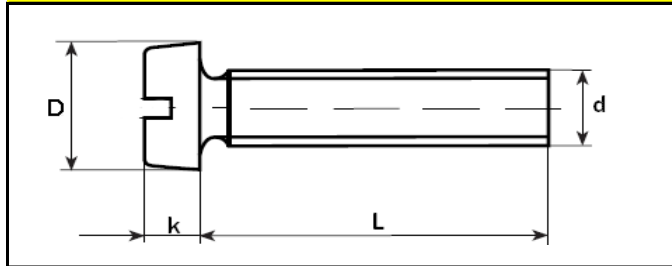

PRECIOS UNIDAD

ROSCA d M	M3	M4	M5	M6	M8
D	5,6	7	8,5	10	13
K	2	2,6	3,3	3,9	5

LONGITUDES (L)	PRECIOS UNIDAD				
	M3	M4	M5	M6	M8
6	0,0084				
8	0,0084	0,0113	0,0198		
10	0,0084	0,0150	0,0167	0,0254	
12	0,0087	0,0118	0,0173	0,0271	
16	0,0085	0,0116	0,0180	0,0274	0,0427
20	0,0102	0,0130	0,0204	0,0315	0,0484
25	0,0118	0,0147	0,0231	0,0352	0,0522
30	0,0149	0,0176	0,0258	0,0379	0,0570
35	0,0188	0,0208	0,0292	0,0418	0,0636
40	0,0208	0,0248	0,0331	0,0462	0,0675
45	0,0298	0,0316	0,0402	0,0523	0,0732
50	0,0321	0,0368	0,0447	0,0576	0,0799
60		0,0418	0,0495	0,0627	0,0883
70				0,0679	0,0959
80				0,0751	0,1036

OTRAS MEDIDAS - CONSULTAR PRECIO Y PLAZO



DIN-963

Tornillo rosca metal cabeza avellanada

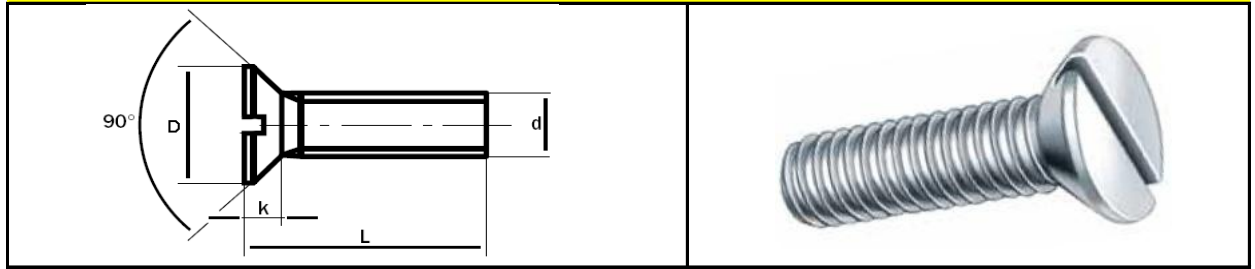

PRECIOS UNIDAD

ROSCA d M	M3	M4	M5	M6	M8
D	5,6	7,5	9,2	11	14,5
K	1,6	2,2	2,5	3	4

LONGITUDES (L)	PRECIOS UNIDAD				
	M3	M4	M5	M6	M8
6	0,0084	0,009			
8	0,0084	0,0113			
10	0,0084	0,0115	0,0167	0,0254	
12	0,0087	0,0118	0,0173	0,0271	0,0462
16	0,0085	0,0116	0,018	0,0274	0,0427
20	0,0102	0,013	0,0204	0,0315	0,0484
25	0,0118	0,0147	0,0231	0,0352	0,0522
30	0,0149	0,0176	0,0258	0,0379	0,0570
35	0,0188	0,0208	0,0292	0,0418	0,0636
40	0,0208	0,0248	0,0331	0,037	0,0675
45	0,0298	0,0316	0,0402	0,0523	0,0732
50	0,0321	0,0368	0,0447	0,0576	0,0799
60		0,0418	0,0495	0,0627	0,0883
70			0,0502	0,0679	0,0959
80				0,0751	0,1036

OTRAS MEDIDAS - CONSULTAR PRECIO Y PLAZO



DIN-7981

Tornillo rosca chapa cabeza alomada philips

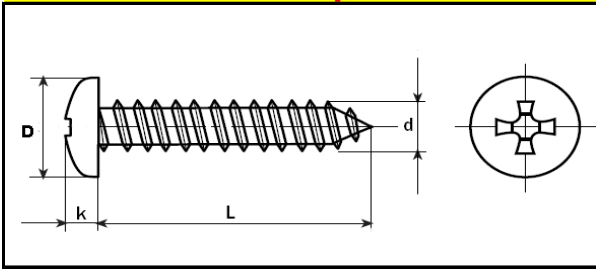

PRECIOS UNIDAD

ROSCA d	2,9	3,5	3,9	4,2	4,8	5,5	6,3
NUMERO	4	6	7	8	10	12	14
D	5,6	6,9	7,5	8,2	9,5	10,8	12,5
k	2,2	2,6	2,8	3,05	3,55	3,95	4,55
Nr. Philips	PH-1	PH-2	PH-2	PH-2	PH-2	PH-3	PH-3

d mm	L mm	Embalaje	Precio	d mm	L mm	Embalaje	Precio
------	------	----------	--------	------	------	----------	--------

2,9 x 6,5	500	0,0126	4,8 x 9,5	500	0,0233
2,9 x 9,5	500	0,0133	4,8 x 13	500	0,0257
2,9 x 13	500	0,0141	4,8 x 16	500	0,0278
2,9 x 16	500	0,0149	4,8 x 19	500	0,0299
2,9 x 19	500	0,0157	4,8 x 22	500	0,0320
2,9 x 22	500	0,0173	4,8 x 25	500	0,0341
2,9 x 25	500	0,0181	4,8 x 32	500	0,0392
			4,8 x 38	500	0,0433
3,5 x 6,5	500	0,0141	4,8 x 45	500	0,0525
3,5 x 9,5	500	0,0153	4,8 x 50	400	0,0679
3,5 x 13	500	0,0173	4,8 x 60	300	0,0795
3,5 x 16	500	0,0183	4,8 x 70	300	0,0912
3,5 x 19	500	0,0194			
3,5 x 22	500	0,0205	5,5 x 13	500	0,0325
3,5 x 25	500	0,0215	5,5 x 16	500	0,0354
3,5 x 32	500	0,0240	5,5 x 19	500	0,0383
3,5 x 38	500	0,0264	5,5 x 22	500	0,0408
			5,5 x 25	500	0,0435
3,9 x 6,5	500	0,0157	5,5 x 32	500	0,0520
3,9 x 9,5	500	0,0178	5,5 x 38	500	0,0572
3,9 x 13	500	0,0194	5,5 x 45	400	0,0636
3,9 x 16	500	0,0206	5,5 x 50	400	0,0795
3,9 x 19	500	0,0221	5,5 x 60	300	0,1002
3,9 x 22	500	0,0233	5,5 x 70	300	0,1132
3,9 x 25	500	0,0248			
3,9 x 32	500	0,0279	6,3 x 13	500	0,0371
3,9 x 38	500	0,0308	6,3 x 16	500	0,0429
3,9 x 45	500		6,3 x 19	500	0,0472
			6,3 x 22	500	0,0531
4,2 x 6,5	500	0,0175	6,3 x 25	500	0,0588
4,2 x 9,5	500	0,0191	6,3 x 32	500	0,0811
4,2 x 13	500	0,0206	6,3 x 38	400	0,0922
4,2 x 16	500	0,0222	6,3 x 45	300	0,1084
4,2 x 19	500	0,0237	6,3 x 50	300	0,1234
4,2 x 22	500	0,0252	6,3 x 60	300	0,1376
4,2 x 25	500	0,0266	6,3 x 70	300	
4,2 x 32	500	0,0304			
4,2 x 38	500	0,0334			
4,2 x 45	500	0,0369			
4,2 x 50	500	0,0531			

OTRAS MEDIDAS CONSULTAR



DIN-7982

Tornillo rosca chapa cabeza plana philips

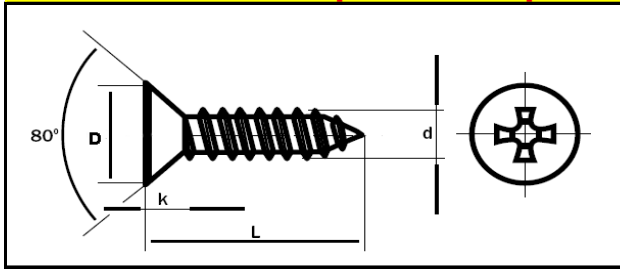

PRECIOS UNIDAD

ROSCA d	2,9	3,5	3,9	4,2	4,8	5,5	6,3
NUMERO	4	6	7	8	10	12	14
D	5,6	6,9	7,5	8,2	9,5	10,8	12,5
k	2,2	2,6	2,8	3,05	3,55	3,95	4,55
Nr. Philips	PH-1	PH-2	PH-2	PH-2	PH-2	PH-3	PH-3

d mm	L mm	Embalaje	Precio	d mm	L mm	Embalaje	Precio
2,9 x 6,5		500	0,0126	4,8 x 9,5		500	
2,9 x 9,5		500	0,0133	4,8 x 13		500	0,0257
2,9 x 13		500	0,0141	4,8 x 16		500	0,0278
2,9 x 16		500		4,8 x 19		500	0,0299
2,9 x 19		500	0,0157	4,8 x 22		500	0,0320
2,9 x 22		500		4,8 x 25		500	0,0341
2,9 x 25		500	0,0181	4,8 x 32		500	0,0392
				4,8 x 38		500	0,0433
3,5 x 6,5		500	0,0141	4,8 x 45		500	0,0525
3,5 x 9,5		500	0,0153	4,8 x 50		400	0,0679
3,5 x 13		500	0,0173	4,8 x 60		300	0,0795
3,5 x 16		500	0,0183	4,8 x 70		300	0,0912
3,5 x 19		500	0,0194				
3,5 x 22		500	0,0205	5,5 x 13		500	
3,5 x 25		500	0,0215	5,5 x 16		500	0,0354
3,5 x 32		500	0,0240	5,5 x 19		500	0,0383
3,5 x 38		500	0,0264	5,5 x 22		500	0,0408
				5,5 x 25		500	0,0435
3,9 x 6,5		500	0,0157	5,5 x 32		500	0,0520
3,9 x 9,5		500		5,5 x 38		500	0,0520
3,9 x 13		500	0,0194	5,5 x 45		400	0,0636
3,9 x 16		500	0,0206	5,5 x 50		400	0,0795
3,9 x 19		500	0,0221	5,5 x 60		300	
3,9 x 22		500	0,0233	5,5 x 70		300	0,1132
3,9 x 25		500	0,0248				
3,9 x 32		500	0,0279	6,3 x 13		500	
3,9 x 38		500	0,0308	6,3 x 16		500	
3,9 x 45		500		6,3 x 19		500	
				6,3 x 22		500	
4,2 x 6,5		500		6,3 x 25		500	0,0588
4,2 x 9,5		500	0,0191	6,3 x 32		500	
4,2 x 13		500	0,0206	6,3 x 38		400	
4,2 x 16		500	0,0222	6,3 x 45		300	0,1084
4,2 x 19		500	0,0237	6,3 x 50		300	0,1234
4,2 x 22		500	0,0252	6,3 x 60		300	
4,2 x 25		500	0,0266	6,3 x 70		300	
4,2 x 32		500	0,0304				
4,2 x 38		500	0,0334				
4,2 x 45		500	0,0369				
4,2 x 50		500	0,0531				

OTRAS MEDIDAS CONSULTAR



DIN-7971

Tornillo rosca chapa cabeza alomada ranurado

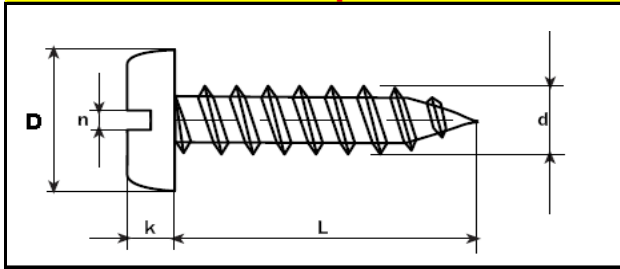

PRECIOS UNIDAD

ROSCA d	2,9	3,5	3,9	4,2	4,8	5,5	6,3
NUMERO	4	6	7	8	10	12	14
D	5,6	6,9	7,5	8,2	9,5	10,8	12,5
k	2,2	2,6	2,8	3,05	3,55	3,95	4,55

d mm	L mm	Embalaje	Precio	d mm	L mm	Embalaje	Precio
2,9	6,5	500	0,0126	4,8	9,5	500	0,0233
2,9	9,5	500	0,0133	4,8	13	500	0,0257
2,9	13	500	0,0141	4,8	16	500	0,0278
2,9	16	500	0,0149	4,8	19	500	0,0299
2,9	19	500	0,0157	4,8	22	500	0,0320
2,9	22	500		4,8	25	500	0,0341
2,9	25	500	0,0181	4,8	32	500	0,0392
				4,8	38	500	0,0433
3,5	6,5	500	0,0141	4,8	45	500	0,0525
3,5	9,5	500	0,0153	4,8	50	400	0,0679
3,5	13	500	0,0173	4,8	60	300	0,0795
3,5	16	500	0,0183	4,8	70	300	0,0912
3,5	19	500	0,0194				
3,5	22	500	0,0205	5,5	13	500	0,0325
3,5	25	500	0,0215	5,5	16	500	0,0354
3,5	32	500	0,0240	5,5	19	500	0,0383
3,5	38	500	0,0264	5,5	22	500	0,0408
				5,5	25	500	0,0435
3,9	6,5	500	0,0157	5,5	32	500	0,0520
3,9	9,5	500	0,0178	5,5	38	500	0,0572
3,9	13	500	0,0194	5,5	45	400	0,0636
3,9	16	500	0,0206	5,5	50	400	0,0795
3,9	19	500	0,0221	5,5	60	300	0,1002
3,9	22	500	0,0233	5,5	70	300	0,1132
3,9	25	500	0,0248				
3,9	32	500	0,0279	6,3	13	500	0,0371
3,9	38	500	0,0308	6,3	16	500	0,0429
3,9	45	500		6,3	19	500	0,0472
				6,3	22	500	0,0531
4,2	6,5	500	0,0175	6,3	25	500	0,0588
4,2	9,5	500	0,0191	6,3	32	500	0,0811
4,2	13	500	0,0206	6,3	38	400	0,0922
4,2	16	500	0,0222	6,3	45	300	0,1084
4,2	19	500	0,0237	6,3	50	300	0,1234
4,2	22	500	0,0252	6,3	60	300	
4,2	25	500	0,0266	6,3	70	300	
4,2	32	500	0,0304				
4,2	38	500	0,0334				
4,2	45	500	0,0369				
4,2	50	500	0,0531				

OTRAS MEDIDAS CONSULTAR



DIN-7972

Tornillo rosca chapa cabeza plana ranurado

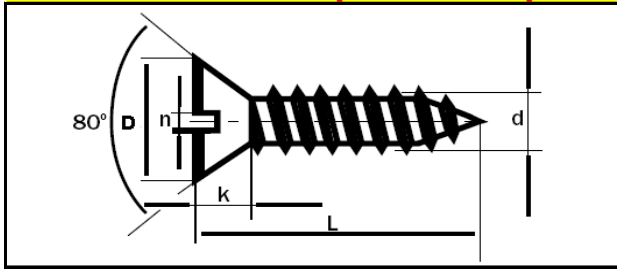

PRECIOS UNIDAD

ROSCA d	2,9	3,5	3,9	4,2	4,8	5,5	6,3
NUMERO	4	6	7	8	10	12	14
D	5,6	6,9	7,5	8,2	9,5	10,8	12,5
k	2,2	2,6	2,8	3,05	3,55	3,95	4,55

d mm	L mm	Embalaje	Precio	d mm	L mm	Embalaje	Precio
2,9	6,5	500	0,0126	4,8	9,5	500	
2,9	9,5	500		4,8	13	500	0,0257
2,9	13	500		4,8	16	500	0,0278
2,9	16	500	0,0149	4,8	19	500	0,0299
2,9	19	500		4,8	22	500	0,0320
2,9	22	500	0,0173	4,8	25	500	0,0341
2,9	25	500		4,8	32	500	0,0392
				4,8	38	500	0,0433
3,5	6,5	500		4,8	45	500	0,0525
3,5	9,5	500	0,0153	4,8	50	400	0,0679
3,5	13	500	0,0173	4,8	60	300	
3,5	16	500	0,0183	4,8	70	300	0,0912
3,5	19	500	0,0194				
3,5	22	500	0,0205	5,5	13	500	
3,5	25	500	0,0215	5,5	16	500	0,0354
3,5	32	500	0,0240	5,5	19	500	0,0383
3,5	38	500		5,5	22	500	0,0408
				5,5	25	500	0,0435
3,9	6,5	500		5,5	32	500	0,0520
3,9	9,5	500	0,0178	5,5	38	500	0,0572
3,9	13	500	0,0194	5,5	45	400	
3,9	16	500	0,0206	5,5	50	400	0,0795
3,9	19	500	0,0221	5,5	60	300	0,1002
3,9	22	500	0,0233	5,5	70	300	0,1132
3,9	25	500	0,0248				
3,9	32	500	0,0279	6,3	13	500	
3,9	38	500	0,0308	6,3	16	500	0,0429
3,9	45	500		6,3	19	500	0,0472
				6,3	22	500	
4,2	6,5	500		6,3	25	500	0,0588
4,2	9,5	500		6,3	32	500	0,0811
4,2	13	500		6,3	38	400	0,0922
4,2	16	500	0,0222	6,3	45	300	0,1084
4,2	19	500	0,0237	6,3	50	300	0,1234
4,2	22	500	0,0252	6,3	60	300	
4,2	25	500	0,0266	6,3	70	300	
4,2	32	500	0,0304				
4,2	38	500	0,0334				
4,2	45	500					
4,2	50	500	0,0531				

OTRAS MEDIDAS CONSULTAR



DIN-7504-N

Tornillo rosca chapa cabeza alomada autotaladrante

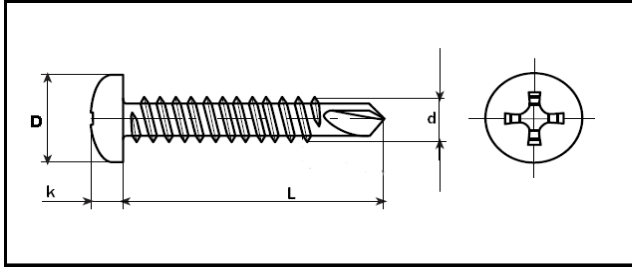

PRECIOS UNIDAD

ROSCA d	2,9	3,5	3,9	4,2	4,8	5,5	6,3
---------	-----	-----	-----	-----	-----	-----	-----

D		6,9	7,5	8,2	9,5	10,8	
k		2,6	2,8	3,05	3,55	3,95	

d mm	L mm	Precio	d mm	L mm	Precio
3,5	9,5	0,0086	4,8	13	0,0191
3,5	13	0,0107	4,8	16	0,0206
3,5	16	0,0116	4,8	19	0,0222
3,5	19	0,0127	4,8	22	0,0267
3,5	22	0,0142	4,8	25	0,0267
3,5	25	0,0154	4,8	32	0,0308
3,5	32	0,0191	4,8	38	0,0352
			4,8	45	0,0392
3,9	13	0,0127	4,8	50	0,0590
3,9	16	0,0135	4,8	60	0,0607
3,9	19	0,0147			
3,9	22	0,0184	5,5	19	0,0308
3,9	25	0,0200	5,5	22	0,0332
3,9	32	0,0219	5,5	25	0,0336
3,9	38	0,0251	5,5	32	0,0412
			5,5	38	0,0448
4,2	13	0,0135	5,5	45	0,0516
4,2	16	0,0152	5,5	60	0,0691
4,2	19	0,0163	5,5	73	0,0817
4,2	22	0,0184			
4,2	25	0,0200			
4,2	32	0,0235			
4,2	38	0,0267			
4,2	50	0,0349			

OTRAS MEDIDAS CONSULTAR

Tornillo rosca chapa cabeza plana autotaladrante

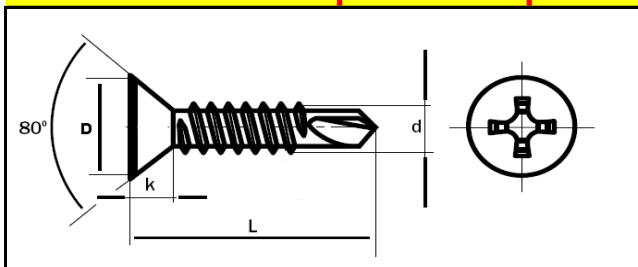

PRECIOS UNIDAD

ROSCA d	2,9	3,5	3,9	4,2	4,8	5,5	6,3
---------	-----	-----	-----	-----	-----	-----	-----

D		6,8	7,5	8,1	9,5	10,8	
k		2,1	2,3	2,5	3	3,4	

d mm	L mm	Precio	d mm	L mm	Precio
------	------	--------	------	------	--------

3,5	x	9,5	0,0089	4,8	x	13	0,0162
3,5	x	13	0,0098	4,8	x	16	0,0186
3,5	x	16	0,0105	4,8	x	19	0,0202
3,5	x	19	0,0118	4,8	x	25	0,0224
3,5	x	22	0,0134	4,8	x	32	0,0303
3,5	x	25	0,0148	4,8	x	38	0,0350
				4,8	x	50	0,0441
3,9	x	13	0,0107				
3,9	x	16	0,0124				
3,9	x	19	0,0139	5,5	x	19	0,0269
3,9	x	22	0,0156	5,5	x	25	0,0303
3,9	x	25	0,0170	5,5	x	32	0,0402
3,9	x	32	0,0210	5,5	x	38	0,0456
3,9	x	38	0,0226	5,5	x	50	0,0559
4,2	x	13	0,0128				
4,2	x	16	0,0141				
4,2	x	19	0,0155				
4,2	x	22	0,0180				
4,2	x	25	0,0203				
4,2	x	32	0,0232				
4,2	x	38	0,0262				

OTRAS MEDIDAS CONSULTAR

Tornillo rosca chapa cabeza hexagonal autotaladrante

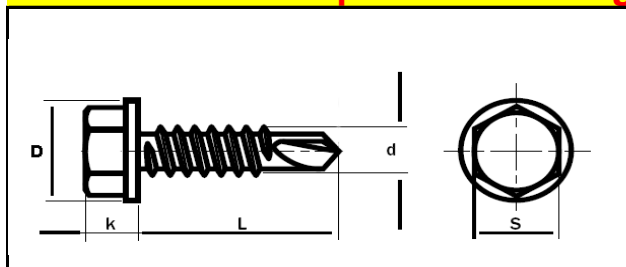

PRECIOS UNIDAD

ROSCA d	2,9	3,5	3,9	4,2	4,8	5,5	6,3
---------	-----	-----	-----	-----	-----	-----	-----

D		8,3		8,8	10,5	11	13,2
S		5,5		7	8	8	10
k		3,45		4,25	4,45	5,45	6,45

d mm	L mm	Precio	d mm	L mm	Precio
3,5	9,5	0,0110	5,5	19	0,0327
3,5	13	0,0126	5,5	22	0,0363
3,5	16	0,0136	5,5	25	0,0388
3,5	19	0,0143	5,5	32	0,0456
3,5	25	0,0179	5,5	38	0,0505
3,5	32	0,0203	5,5	50	0,0607
			5,5	63	0,0753
			5,5	75	0,0874
4,2	13	0,0165	6,3	19	0,0520
4,2	16	0,0178	6,3	25	0,0561
4,2	19	0,0201	6,3	32	0,0637
4,2	25	0,0246	6,3	38	0,0693
4,2	32	0,0269	6,3	50	0,0847
4,2	38	0,0313	6,3	63	0,1004
			6,3	75	0,1167
4,8	13	0,0228	6,3	80	0,1230
4,8	16	0,0248	6,3	90	0,1541
4,8	19	0,0263	6,3	100	0,1706
4,8	25	0,0300	6,3	110	0,1836
4,8	32	0,0349	6,3	120	0,2210
4,8	38	0,0387	6,3	130	0,2419
			6,3	140	0,2593

OTRAS MEDIDAS CONSULTAR



DIN-7505-A

Tornillo aglomerado cabeza plana pozidriv

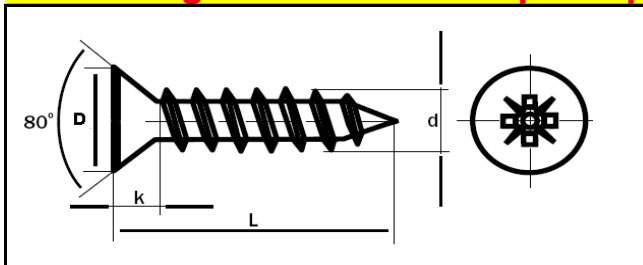

PRECIOS UNIDAD

ROSCA d	2,5	3	3,5	4	4,5	5	6
---------	-----	---	-----	---	-----	---	---

D	5	6	7
k	1,4	1,8	2
Punta	PZ-1	PZ-1	PZ-2

	8	9	10	12
	2,35	2,55	2,85	3,6
	PZ-2	PZ-2	PZ-2	PZ-3

d mm	L mm	Embalaje	Precio
------	------	----------	--------

2,5 x 12	1000	0,0127
2,5 x 16	1000	0,0141
2,5 x 20	1000	0,0150
2,5 x 25	1000	0,0169
3 x 12	1000	0,0127
3 x 16	1000	0,0141
3 x 20	1000	0,0150
3 x 25	1000	0,0169
3 x 30	1000	0,0203
3 x 35	1000	0,0236
3 x 40	1000	0,0269
3,5 x 12	1000	0,0141
3,5 x 16	1000	0,0156
3,5 x 20	1000	0,0163
3,5 x 25	1000	0,0167
3,5 x 30	1000	0,0201
3,5 x 35	1000	0,0237
3,5 x 40	1000	0,0307
3,5 x 45	500	0,0360
3,5 x 50	500	0,0412
4 x 16	1000	0,0186
4 x 20	1000	0,0189
4 x 25	1000	0,0208
4 x 30	1000	0,0236
4 x 35	1000	0,0283
4 x 40	500	0,0329
4 x 45	500	0,0401
4 x 50	500	0,0471
4 x 60	300	0,0589

d mm	L mm	Embalaje	Precio
------	------	----------	--------

4,5 x 16	1000	0,0257
4,5 x 20	1000	0,0259
4,5 x 25	1000	0,0283
4,5 x 30	1000	0,0329
4,5 x 35	1000	0,0354
4,5 x 40	500	0,0400
4,5 x 45	500	0,0519
4,5 x 50	500	0,0566
4,5 x 60	300	0,0658
4,5 x 70	300	0,0811
4,5 x 80	300	0,1292
5 x 20	1000	0,0329
5 x 25	1000	0,0354
5 x 30	1000	0,0400
5 x 35	1000	0,0448
5 x 40	500	0,0519
5 x 45	500	0,0590
5 x 50	500	0,0613
5 x 60	300	0,0778
5 x 70	300	0,1108
5 x 80	200	0,1524
5 x 90	100	0,1939
5 x 100	100	0,2355
6 x 30	200	0,0659
6 x 35	200	0,0707
6 x 40	200	0,0778
6 x 45	200	0,0849
6 x 50	200	0,0895
6 x 60	200	0,1085
6 x 70	200	0,1344
6 x 80	100	0,1763
6 x 90	100	0,2181
6 x 100	100	0,2599
6 x 120	100	0,3515
6 x 140	100	0,5456

OTRAS MEDIDAS CONSULTAR



Tornillo aglomerado cabeza plana con ranura

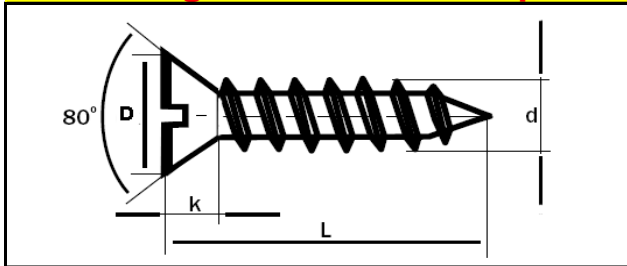

PRECIOS UNIDAD

ROSCA d	2,5	3	3,5	4	4,5	5	
NUMERO	17	18	19	20	21	22	
D	5,4	6	7	8	9	10	
k	1,35	1,5	1,75	2	2,25	2,5	

d mm	L mm	Precio	d mm	L mm	Precio
2,5	x 10	0,0090	4	x 25	0,0145
2,5	x 12	0,0082	4	x 30	0,0171
2,5	x 16	0,0085	4	x 35	0,0191
2,5	x 20	0,0090	4	x 40	0,0221
2,5	x 25	0,0109	4	x 45	0,0246
2,5	x 30	0,0135	4	x 50	0,0287
			4	x 60	0,0314
			4	x 70	0,0337
3	x 10	0,0103	4,5	x 16	0,0180
3	x 12	0,0085	4,5	x 20	0,0189
3	x 16	0,0090	4,5	x 25	0,0196
3	x 20	0,0094	4,5	x 30	0,0212
3	x 25	0,0105	4,5	x 35	0,0238
3	x 30	0,0144	4,5	x 40	0,0270
3	x 35	0,0163	4,5	x 45	0,0306
3	x 40	0,0184	4,5	x 50	0,0337
			4,5	x 60	0,0421
			4,5	x 70	0,0525
3,5	x 10	0,0105	5	x 20	0,0202
3,5	x 12	0,0099	5	x 25	0,0221
3,5	x 16	0,0103	5	x 30	0,0257
3,5	x 20	0,0108	5	x 35	0,0291
3,5	x 25	0,0116	5	x 40	0,0306
3,5	x 30	0,0158	5	x 45	0,0330
3,5	x 35	0,0193	5	x 50	0,0382
3,5	x 40	0,0201	5	x 60	0,0477
3,5	x 45	0,0211	5	x 70	0,0596
3,5	x 50	0,0230			
4	x 12	0,0124			
4	x 16	0,0129			
4	x 20	0,0137			

Hasta agotar existencias





DIN-571

Tornillo tirafondo para madera cabeza hexagonal

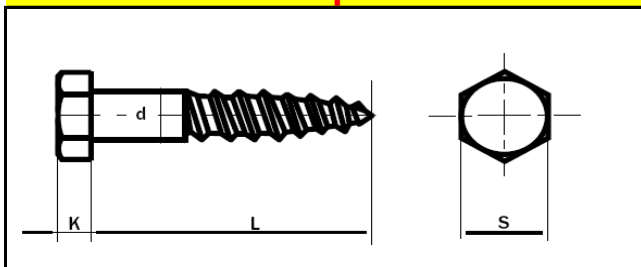

PRECIOS UNIDAD

ROSCA d	5	6	7	8	10
s	8	10	12	13	17
k	3,5	4	4,5	5,5	7

d mm	L mm	Precio	d mm	L mm	Precio
5	x 30	0,0443	8	x 50	0,1051
5	x 40	0,0520	8	x 60	0,1207
5	x 50	0,0659	8	x 70	0,1361
5	x 60	0,0692	8	x 80	0,1528
			8	x 90	0,1710
6	x 25	0,0389	8	x 100	0,1854
6	x 30	0,0434	8	x 110	0,2203
6	x 35	0,0496	8	x 120	0,2371
6	x 40	0,0516			
6	x 50	0,0606			
6	x 60	0,0699	10	x 50	0,2006
6	x 70	0,0868	10	x 60	0,2277
6	x 80	0,1286	10	x 70	0,2363
			10	x 80	0,2609
7	x 40	0,0784	10	x 90	0,3028
7	x 50	0,0918	10	x 100	0,3236
7	x 60	0,1049	10	x 110	0,3562
7	x 70	0,1169	10	x 120	0,3712
7	x 80	0,1526			
7	x 90	0,1685			
7	x 100	0,2122			

OTRAS MEDIDAS CONSULTAR





Tornillo tirador

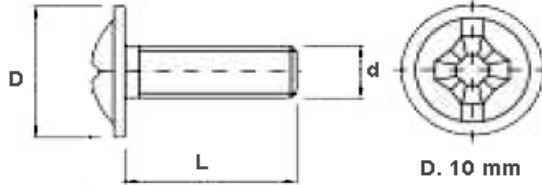

PRECIOS UNIDAD

d mm L mm	Precio
4 x 20	CONSULTAR
4 x 22	CONSULTAR
4 x 25	CONSULTAR
4 x 30	CONSULTAR
4 x 35	CONSULTAR

OTRAS MEDIDAS CONSULTAR



Tornillo Silla



PRECIOS UNIDAD

d mm L mm	Precio	d mm L mm	Precio
3/16 x 10	CONSULTAR	3/16 x 35	CONSULTAR
3/16 x 15	CONSULTAR	3/16 x 40	CONSULTAR
3/16 x 20	CONSULTAR	3/16 x 45	CONSULTAR
3/16 x 25	CONSULTAR	3/16 x 50	CONSULTAR
3/16 x 30	CONSULTAR	3/16 x 60	CONSULTAR

OTRAS MEDIDAS CONSULTAR





TACO NYLON

TACO NYLON STANDARD

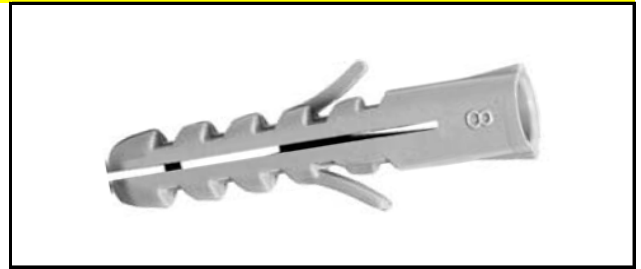
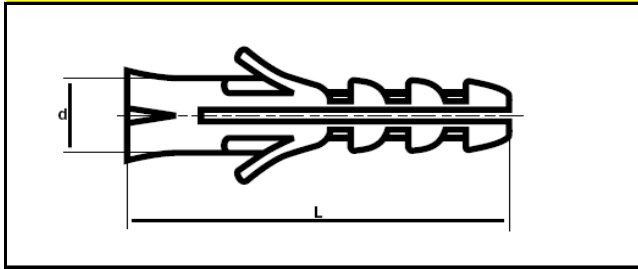

PRECIO UNIDAD							
MEDIDA	4	5	6	7	8	10	12
PRECIO	0,0052	0,0065	0,0082	0,0135	0,0270	0,0367	0,0514



Rodaunión



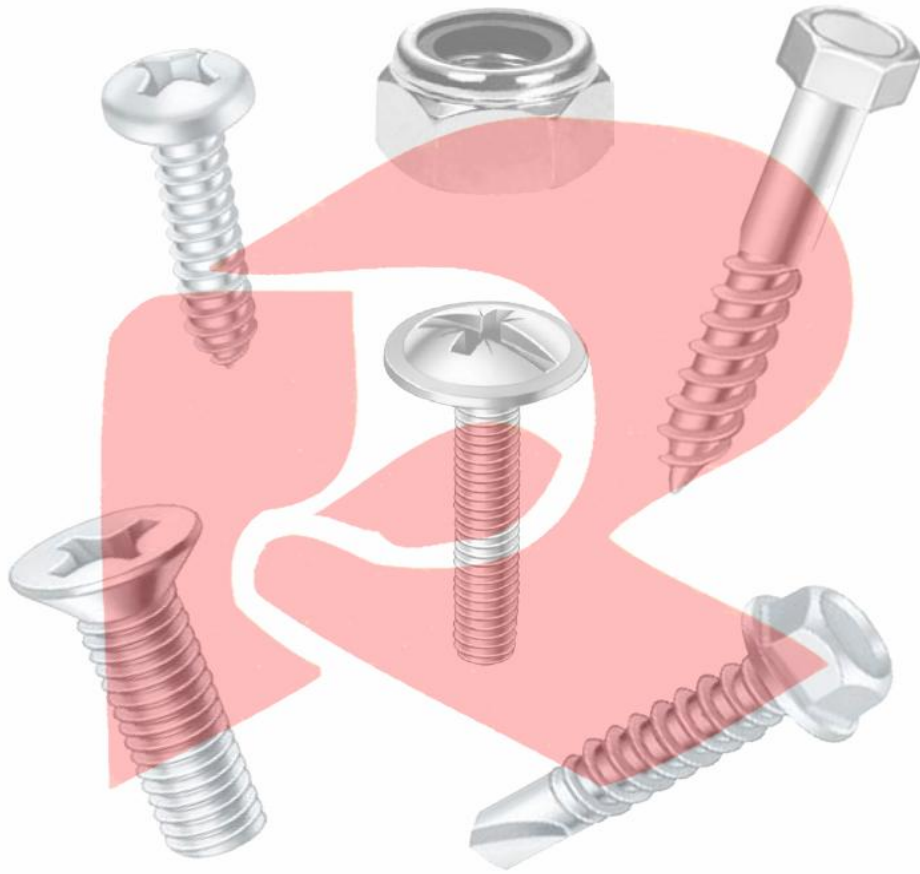

SUMINISTROS INDUSTRIALES

Rodaunión, s.l.

**C/ LA RIOJA, 17
03006 ALICANTE
ALICANTE**

**TLF. 965114462* - 965283312
FAX. 965103353**

**e-mail: info@rodaunion.es
web: www.rodaunion.es**